



aocheng HARDWARE



DARF
PROJECT ADVISORS

YONGJIA AOCHENG HARDWARE CO., LTD

Transfer Pump Series

Fuel Dispenser Accessories Series

Flow Meter Series





Certificates



Aocheng Company Introduction

YONGJIA AOCHENG HARDWARE CO., LTD. which was established in 2007, and has been manufacturing fuel nozzle , transfer pump, flow meter and fuel dispenser parts over many years.

After our factory certificated by ISO9000-2000 in the year 2009, and most of products get CE in 2008.

There are also many products that are under process of UL approval now. Some of the main activities and products of our company are below.

At present, Our Company exports 70% of our products, which are produced by our professional staffs and labors. We hope to share our ingenious and collaborative spirit that enables our company to succeed.

Contents

TRANSFER TANK PUMP SERIES

Fuel Pump and Tank	02-04.
DC Transfer Pump	06-07.
AC Transfer Pump	08-10.
EX-Proof Pump	11.
SB QBY Pump	12.
Adblue Field	13.
Oil Grease Field	14-17.

FUEL DISPENSOR ACCESSORIES SERIES

Automatic Nozzle	19-22.
Manual Nozzle	23-24.
LPG Nozzle & Filter, Flow Meter	25-27.
Submersible turbine pump	28.
Nozzle Holder	29.
Breakaway, Swivels, fittings	30-32.

FLOW METER SERIES

Positive Displacement Flow Meter	34-35.
Measuring Nozzle & Meter	36-37.
Turbine Measuring Nozzle	38.
Machinery Meter	39.
Manual Pump	40.
Oil Tank Accessories	41-44.





China Aocheng

FUEL PUMP, TANK SERIES

website: www.china-aocheng.com



Fuel Dispenser Pump

WS50/90



WS50/90

This type combined by Nozzle, Display, Keyboard, Bennett Flow meter
Technical index and parameter

Medium	Diesel, Kerosene
Accuracy	±0.5%
Hose Length	15m
Volt Frequency	12/24/220/110V (50HZ/60HZ)
Totalizer Range	000 to 9999999999.99 1
Delivery Rate	5 to 50L/min/9 to 90L/min
Range of Price	0.01 to 9999
Rating Power	0.55KW
Measurable Minimum	5L/9L
Preset Min Value	0.01 to 0.99L

FB40-EX



12/24/220V



GG80

This fuel dispenser pump combine with pump, flow meter, hose reel, and digit display, it can use for farm machinery, fuel station tank filling application. and the most befinet is easy to operate the hose and filling.

Medium	Petrol
Ambient temperature	-25°C ~ +55°C
Humidity	≤95%
Max flow	50L/min or 90 L/min
Accuracy	±1%
Repeating error	≤0.5%
Power	DC12v DC24v 220v
Hose Length	15m
Filter	Yes
Power Switch	Yes

GG80



12/24/220V

Poly Fuel Tank

DTK220



DTK440

- 1.Those models are compatible with Diesel, gasoline, ADblue.
- 2.Specifications: Fuel Pump, hose, meter(selection), filter, nozzle.
3. Heavy duty rugged built poly construction.
4. Built-in forklift pockets to carry on tank.
5. Max.flow: 10 GPM
6. Fuel level indicator
7. Pre-molded recesses with ratchet straps
- 8 . 6.5 ft battery power cable
9. Max suction: 10 ft
10. for transportation 13 ft delivery hose
11. Lockable lid for fuel pump and accessories
12. Fuel nozzle flow rate:7-10 GPM
- 13 tow inch filling plug with air vent device of three, One inch outlet fitting
15. circumstances(pressure/de-pressure/overturning)
16. Automatic diesel dispensing nozzle
17. Lift distance: 20 ft

Type	Medium	Preset	Size (cm) (L-W-H)	Weight (kg)	Volume (l)
DTK 220	Die, petr, adblue	No	92x62x69	34	220
DTK 440		No	120x80x80	62	440
DTK 500		Yes	107x100x74	62	500
DTK 110		No	57x47x108	28	110



Caddy Tank

14-gallon fuel tank on wheels, ideal for farm and rural use as well as marine and recreational use. Sturdy wheels making it easy to transport and you can take it to go anywhere. Features 2 brass shut off valves one at the tank and one at the hose. This allows for easy disconnect with no fuel spillage. 10 foot hose is automotive-grade rubber. And the caddy comes equipped with a hose hanger for easy storage. With 6v battery pump, filling nozzles

Material	High-density polyethylene (plastic)
LxWxH	16.2 x 12.7 x 33.8 inches
Weight	11.5 kg
Capacity	14 Gallons
Fuel Type	Gasoline, diesel
Hose Length	10 Feet

DTK50



hand

Motor

Poly Fuel Tank

DTK500



Note: Above sheet is standard one, we may install flow meter OGM-25, automatically nozzle AC-11A, 1.5m suction hose and check vale according to customer requirement.



JC5,10,20

Jerry Can

EASY TO USE GAS CAN – 5, 10, 20 liter fuel container for easy refilling of lawnmowers, chainsaws, yard tools, recreational vehicles, ATVs, motorcycles, and other gas-powered equipment
 SELF-VENTING SPOUT – The self-venting spout helps create a smooth fuel flow to minimize spilling
 Material: polyethylene



OC1,2,3,5

Oil Can

Now With a Spout Cap and Lid to Keep Out Contaminants. Our popular 5 litre Dispenser with a spout cap and lid to keep out dirt, dust and other contaminants. Translucent white polyethylene material enables the user to read the oil level on the container up to 5 liter and is marked in both quarts and liters.

TRANSFER PUMP SERIES

website: www.china-aocheng.com



DC Transfer Pump

DCFD40



DC Pump

This DC big flow rate pump is fueling the diesel, kerosene, not for gasoline. And its pump head with iron material, and with 100% copper line, its specification as follows:

- A. With CE Certification, and IP54 Protection
- B. Pump with By pass and Self priming
- C. 4m Delivery hose and 1.5m suction hose
- D. Filter or Check valve

Model	DCFD40	DCFD60	DCFD80
Flow rate	40L/min	60L/min	80L/min
Voltage	12v or 24v	12v or 24v	12 or 24v
Deliver hose	4m	4m	4m
Manual nozzle	Yes	Yes	Yes
Filter	Yes	Yes	Yes
Suction hose	1.5m	1.5m	1.5m

Note: Above sheet is standard one, we may install flow meter FM-120-1, automatically nozzle AC-11A, 1.5m suction hose and check vane according to customer requirement.



DCTP40



DCTP60



DCTP80

Item	Flow Rate	Voltage	Power (w)	Max Pressure	Suction Length
DCTP40	40L/Min	12v or 24v	150	3bar	5m
DCTP60	60L/Min	12v or 24v	200	3bar	5m
DCTP80	80L/min	12v or 24v	250	3bar	5m

DC Transfer Pump

DCTP70



■ DCTP70

This pump is fueling the diesel, kerosene, not for gasoline. And its pump Head with Aluminum, and with 100% copper line, its specification as follows:

- A. With CE Certification. And IP54 Protection
- B. Pump with By pass and Self priming
- C. thermal overload protection
- D. Filter and connectors

Model	Voltage V	Flow rate	Motor running (RPM)
DCTP70	24v	40L/Min	1400
	12v	70L/min	2800

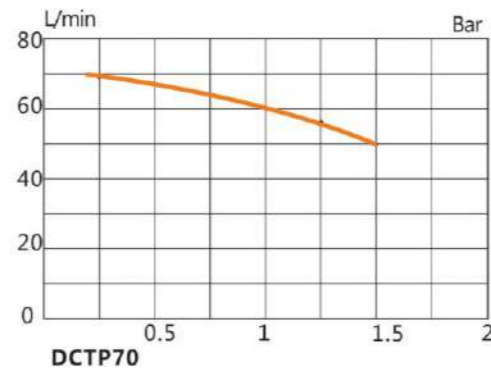

DCFD40A



DCTP20



DCTP20-38
DCTP20-51

■ DCTP20

This pump is smart pump, and designed the switch on the hand, and with ss outside shell protection! And dirty oil viewer

Model	Voltage V	Flow rate	Motor running (RPM)
DCTP20	24v or 12v	30L/min	2800

■ DCFD40A

Model	Voltage	Flow rate	Motor (RPM)	Manual nozzle
DCFD40A	24v or 12v	40L/Min	2800	YES

AC Transfer Pump

ACFD60



■ AC Pump

This AC big flow rate pump is fueling the diesel, kerosene, not for gasoline. And its pump head with iron material, and with 100% copper line, its specification as follows:

- A. With CE Certification. and IP54 Protection
- B. Pump with By pass and Self priming
- C. 4m Delivery hose and 1.5m suction hose
- D. Filter or Check valve

Model	ACFD40	ACFD60	ACFD70	ACFD80	ACFD100
Flow rate	40L/min	60L/min	70L/min	80L/min	100L/min
Power	375w	550w	550w	550w	1Kw
Deliver hose	4m	4m	4m	4m	4m
Manual nozzle	Yes	Yes	Yes	Yes	Yes
Filter	Yes	Yes	Yes	Yes	Yes

Note: Above sheet is standard one, we may install flow meter FM-120-1, automatically nozzle AC-11A, 1.5m suction hose and check vale according to customer requirement.



ACTP100



ACTP80



ACTP60

Item	Flow Rate	Voltage	Power (w)	Max Pressure	Suction Length
ACTP40	40L/Min	230v	375	3bar	5m
AC-TP60	60L/Min	230v	550	3bar	5m
AC-TP70	70L/Min	230v	550	3bar	5m
AC-TP80	80L/Min	230v	550	3bar	5m
AC-TP100	100L/min	230v	1000	3bar	5m

AC Transfer Pump

ACFD60A



ACFD60A

This AC big flow rate pump is fueling the diesel, kerosene, not for gasoline. And its pump head with iron material, and with 100% copper line, its specification as follows:

- A. With CE Certification. And IP55 Protection
- B. Pump with By pass and Self priming
- C. 4m Delivery hose and 2m suction hose
- D. Filter or Check valve

Model	ACFD60A	ACFD80A
Flow rate	60L/min	80L/min
Voltage	230v	230v
Deliver hose	4m	4m
Auto nozzle	Yes	Yes
Filter	Yes	Yes

ACFD60D



PRET



ACFD60B



ACFD60B

This type combined by Nozzle, and hose or Flow meter
Technical index and parameter

Model	ACFD60B	ACFD60D
Flow rate	60L/min	60L/min
Voltage	230V	230V
Deliver hose	4m	4m
Auto nozzle	yes	yes
Filter	yes	yes

AC Transfer Pump

ACJZ40A



ACJZ40

This smart fuel pump is fueling the diesel, kerosene, not for gasoline. Very popular in Poland market, And its pump head with iron material, and with 100% copper line, its specification as follows:

- A. With IP55 protection
- B. With emergency shut off switch
- C. Convince to use and light.
- D. CE certification
- E. Color: Black, Blue, Yellow

Model	ACJZ40A	ACJZ40B
Body Material	Cast Iron	Cast Iron
Maximum flow rate	40LPM	40LPM
Self Priming	NO	Yes
Voltage	230v, 110, +/-10V	230v, 110, +/-10V
Foot Valve	YES	YES
Pump	ACJZB40A	ACJZB40B



ACJZB40B

ACJZB40A



12,24,220V

DCTP90

Item	Flow Rate	Voltage	Power (w)	Max Pressure	Self priming	Medium
ACJZB40A	40L/Min	230v	600	3bar	No	Diesel
ACJZB40B	40L/Min	230v	600	3bar	Yes	
DCTP90	90L/Min	12,24,220v	750	3bar	Yes	Diesel

EX-Proof Pump

ACEX60



12, 24, 220V

ACEX60

This 220V Ex-Proof pump can installed with FM-40G meter in gallons or FM-120 meter in liters, Turbine low meter nozzle or automatic nozzle, or oval gear meter nozzle, etc, like Application picture

Model	ACEX60	DCEX60
Voltage	220v, 50hz	12v, 24v
Body Material	Cast Iron	Cast Iron
Maximum flow rate	60L/Min	60L/Min
Explosion-proof motor	1/3HP	1/3HP
Inlet	1"	1"
Outlet	1"	1"
Motor Speed	2800RPM	3900RPM

DCEX56



12, 24, 220V

DCEX56

This 12V Ex-Proof pump is especially for fueling the GASOLINE, And its pump head with iron material, and with 100% copper line, its specification as follows:

- A. With Ex-Proof Protection
- B. Pump with By pass and Self priming
- C. thermal overload protection
- D. Filter and connectors
- E. 30-minute duty cycle/not for continuous operation

Model	DCEX56	DCEX75
Maximum flow rate	15GPM(57LPM)	20GPM(76LPM)
Explosion-proof motor	1/4HP	1/4HP
Voltage	Dc12v or DC24v	
Threaded tank adapter	2"NPT	2"NPT
Nozzle hanger	Yes	Yes

DCEX76A



SB QBY Pump

SB Pump



QBY Pump



SB Pump

Item	Model	Flow L/min	Head m	Power Kw	Size mm	Inpeller/outle material	Pump tube material
Electric Transfer Pump	SB-1-1	110	7	0.88	50/25	Plastic	SSS
	SB-1-3	110	7	0.88	50/25	SS	SS
	SB-7	100	7	0.55	41/25	Plastic	SS
	SB-6	100	7	0.55	41/25	SS	SS
	SB-3	150	10	0.88(EX)	50/25	Plastic	SS
	SB-3-1	150	10	0.88(EX)	50/25	SS	SS
	SB-2	130	7.5	1.1	50/25	Plastic	Aluminum
	SB-4	150	10	0.88(EX)	50/25	Plastic	Aluminum
Drum Pump	JK-3B	50	2.5	0.12	55/20	Plastic	Aluminum
	JK-3BS	50	2.5	0.12	55/20	Plastic	SS

QBY Pump

Item	Discharge rate (m ³ /H)	Max Lift (m)	Suction (m)	Max air diameter (mm)	Max air preasure (kg/cm ²)	Air source waster rate (m ³ /min)
QBY-10	0.08	0-50	5	1	7 bar	0.3
QBY-15	0-1		5	1		0.3
QBY-20	0-1.5		6	1.5		0.5
QBY-25	0-2.4		7	2.5		0.6
QBY-32	0-5		7	3.5		0.7
QBY-40	0-8		7	4.5		0.6
QBY-50	0-12		7	8		0.9
QBY-65	0-16		7	8		0.9
QBY-80	0-24		7	10		1.5
QBY-100	0-30		7	10		1.5

Adblue Field

ACAD40



Adblue Pump

- A. Permanent magnet and continuous duty,
- B. Built-in Pressure switch automatically starts and stops pump when faucets is opened and closed.
- C. Self-priming so pump can be located above water tank
- D. Runs dry for extended periods of time without damage
- E. Holding excellent motor keep stable temperature of the pump body

Model	ACAD40	DCAD40
Pump Body Material	EPDM	EPDM
Maximum flow rate	40LPM	40LPM
Voltage	230v	12v or 24v
Self Priming	Yes(2.8bar)	Yes(2.8bar)
Medium	Urea, Adblue	Urea, Adblue

DCAD40



Adblue Meter



SS Adblue Pump



Adblue Pump Kit



Adblue Pump Fitter

Item	Flow rate	Auto or Manual	Inlet out	Outlet	
AdblueNozzle(A)	60L/Min	Auto	3/4"	1/2"	
Adblue Nozzle(M)	80L/Min	Manual	3/4"	1/2"	
Adblue Meter	100L/Min		1"	1"	Tubine
Adblue hose	100L/Min		1"	1"	EPDM

Grease Oil Tank

GPT40L



NEW

GPT40L

5 Gallon Capacity Storage: Made of chromium-vanadium steel and cast iron, the grease pump features high hardness and sturdiness. The 5-gallon large capacity allows you to put your oil drum directly into the machine without having to pour oil multiple times. The large quantity of oil it can hold will efficiently cut time in half, while also saving your energy.

360° Universal Grease Gun: The gun head in the grease pump can rotate arbitrarily in multiple directions, meeting different positional needs without restrictions. The thickened suction cup can fit the barrel body without air intake and prevents oil leakage. Additionally, it provides a strong sealing performance, making it easier to discharge oil.

GPT20L



NEW

GPT5L/10L20L40L

OPT200



NEW



NEW

GPT10L-cart

Oil Nozzle

OIL Nozzle



OILN07

OILN01-Oil nozzle easily combined with oil meter to measure and construction of aluminum body swivel, and a in-built balanced valve.

Model	AC-OILN01/03/04/05	AC-OILN02
Pump Body Material	Aluminum	Aluminum
Maximum flow rate	15LPM	15LPM
Working pressure	0.8mpa	0.8mpa
Max working pressure	10mpa	10mpa
Balance valve	Yes	Yes
Automatically nozzle spout	Yes	Rubber Spout
Spout Swivel Angle	360	Fixing
Inlet	1/2"	1/2"



Pneumatical Oil/Grease Pump

P50:1, P5:1,P3:1



P3:1

Heavy-duty pneumatic (air-operated) 3:1 double-action grease/oil transfer pump for medium- to high-viscosity fluids and short- to medium-distance applications.

Provides a high flow rate of up to 3.2 GPM (12LPM); suitable for SAE130 oils/ fluids, including motor oil, synthetic hydraulic oil, gear oil, hydraulic fluid, and automatic transmission fluid (NOT for use with gasoline or diesel)



Type	3:1	5:1	50:1
Medium	Oil, lub	Oil, lub	grease
Flow rate	12-14 L	8-10 L	1-2kg
Length(mm)	940, 580	940,760, 580	1150, 940, 760, 580
LxWxH(4pcs)	290x 290 x 1350	290x 290 x 1350	290x 290 x 1350
Weight (4pcs)	31kg	32kg	28kg

Drum	5L	10L	20L	40L
Capacity	5L/1.5Gal	10 L/3Gal	10 L/3Gal	40 L/ 10Gal
Air Pressure	0.6-0.8Mpa			0.4-0.6Mpa
Tran Pressure	30-40Mpa			20-30Mpa
Pressure Ratio	50 : 1			60 : 1
Grease Output	0.75 L / min			1.5 L / min

Oil Nozzle

OILN03



OILM01



OILM02

OILN03

With oval gear meter for controlling and measuring high viscosity, such as, lubrication, oil, with advantage of high precision and low pressure loss, compact light weight design and easy installation. And it is with LCC display, 5-digital sub-total, with floating point from 0.001 to 999.99, 8 digital non-resettable tantalizer.

Model	OILM01	OILM02	OILM03
Inlet & Outlet	BSPF1/2"	BSPF1/2"	BSPF1/2"
Accuracy	±0.5%	±0.5%	Output with pulse
Repeatability	0.2	0.2	
Max working pressure	7mpa	7mpa	7mpa
Discharge rate per revolution	25ml/r	25ml/r	25ml/r
Battery power	2x1.5v	2x1.5v	2x1.5v
Flow rate	1-30L/min	1-30L/min	1-30L/min



OILM03

OILP01



OILP01

Electric gear pump is designed for various requirements of pumping lubricants, with the construction of die cast aluminum pump body, by pass valve, sintered steel gears, mechanical seal on the motor shaft, with the advantage of quiet operation, high suction capacity/compact design.

Model	OILP01
Flow rate	BSPF1/2"
Pressure	±0.5%
Noise	0.2
Power	7mpa
Vacuum	25ml/r

FUEL DISPENSOR ACCESSORIES SERIES

website: www.china-aocheng.com



Automatic Nozzle

AC-11A



AC-11A



AC-11AP



3/4" 1/2"

AC-11A

AC-11A Automatic Nozzles are made of alloy aluminum and designed with today's customer in mind. Small, trim, light weight, easy and convenient to use.

Inlet Thread	BSPF/NPT 3/4 "
Diameter of spout	3/4" & 1/2"
Color of insulator	red/green/blue/yellow/black
Package	10pcs/carton
Net Weight	13kg
Gross Weight	14kg
Dimension	420×340×400mm

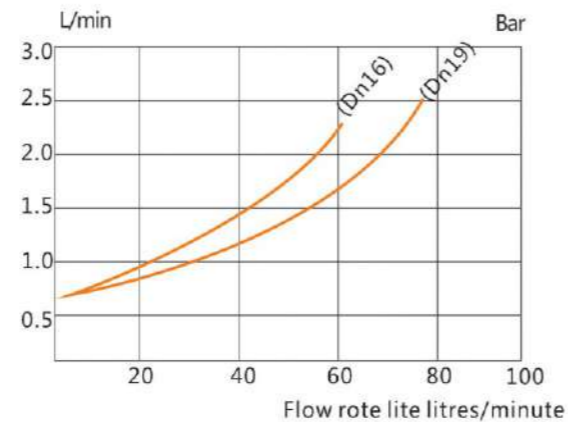

AC Adblue



AC Adblue

This auto nozzle is made of stainless steel 316, and all sealing parts are Viton, It has good features for the Acid material, Urea, Adblue etc.

Inlet Thread	BSPF/NPT 3/4 "
Diameter of spout	1/2"
Color of insulator	blue
Package	10pcs/carton
Net Weight	23kg
Gross Weight	25kg
Dimension	420×340×400mm

Automatic Nozzle

AC-11B



AC-11B

AC-11B Automatic Nozzles are designed specially for self-service pre-pay of card-lock system to help prevent gasoline spills. The AC-11B can not be opened until the pumping system is pressurized and closes automatically when the pressure is removed. This means the AC-11B is closed when placed back to the dispenser. Accurate flow control allows your customers to top off their tank to the exact amount they want, and it's easy to stop gasoline flow precisely.

Inlet Thread	BSPF/NPT
Diameter of spout	3/4" & 1/2"
Color of insulator	red/green/blue/yellow/black
Package	10pcs/carton
Net Weight	13kg
Gross Weight	14kg
Dimension	420×340×400mm

AC-120



1"

AC-120

AC-120 Automatic Nozzles are made of alloy aluminum. Heavy-duty high-flow nozzle, for fueling truck, bus. Low cost, long life and durability.

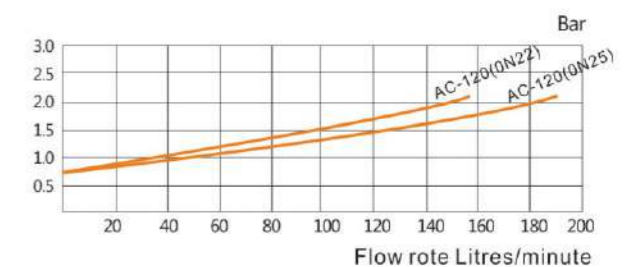

Inlet Thread	BSPF/NPT1"
Diameter of spout	1"
Color of insulator	red/green/blue/yellow/black
Package	10pcs/carton
Net Weight	17kg
Gross Weight	18kg
Dimension	420×340×400mm

Automatic Nozzle

AC-NF80



AC-NF80

AC-NF80 with whole spout to avoid leakage after service long time. The main valve is sealed in two layers to avoid being difficult to run the nozzles when working pressure is too high. The nozzle can be controlled in three grades only with one hand.

Inlet Thread	BSPF/NPT 3/4"
Diameter of spout	3/4" & 1/2"
Color of insulator	red/green/blue/yellow/black
Package	10pcs/carton
Net Weight	13kg
Gross Weight	14kg
Dimension	420×340×400mm

AC-ZVA80



AC-ZVA80
AC-ZVA120

AC-ZVA80 and AC-ZVA120 with tight structure, cute appearance, reduction of pressure loss and increase of the flow. Accurate flow control: allows your customers to top off their tank to the exact amount they want, and it's easy to stop gasoline flow precisely.

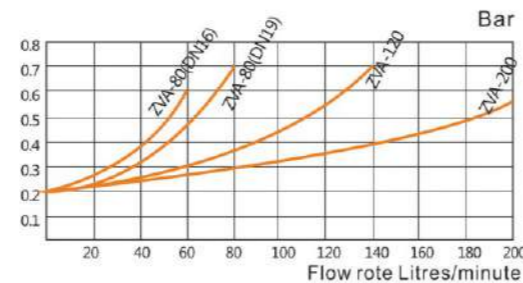

AC-ZVA120



Mould	AC-ZVA80	AC-ZVA120
Inlet Thread	BSPF/NPT 3/4"	BSPF/NPT 1"
Diameter of spout	3/4"	1"
Color of insulator	red/green/blue/yellow/black	red/green/blue/yellow/black
Package	10pcs/carton	10pcs/carton
Net Weight	13kg	17kg
Gross Weight	14kg	18kg
Dimension	420×340×400mm	420×340×400mm

VP Nozzle

AC-VP-60



VP Nozzle

Premium VP nozzles for Vacuum-Assist vapor recovery systems. Designed with an integrated vapor-valve, they are certified on the most used vapor recovery systems in the world. The VP-80 is the most trusted vapor recovery nozzle in the world for the applications it is certified on top dispenser company.

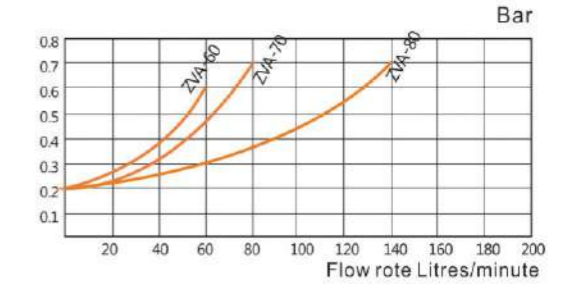

AC-VP-70



Inlet Thread	AC-VP-60
Temperature	-20°C±40°C
Working Pressure	0.22Mpa
Max. Pressure	0.35Mpa
Max. Flowrate	40L/min
Inlet Thread	M34x1.5mm
Weight	1.6Kg

AC-VP-80



Inlet Thread	AC-VP-80
Temperature	-20°C±40°C
Working Pressure	0.22Mpa
Max. Pressure	0.35Mpa
Max. Flowrate	45L/min
Inlet Thread	M34x1.5mm
Weight	1.2Kg

Inlet Thread	AC-VP-70
Temperature	-20°C±40°C
Working Pressure	0.22Mpa
Max. Pressure	0.35Mpa
Max. Flowrate	38L/min
Inlet Thread	M34x1.5mm
Weight	1.6Kg

Automatic Nozzle

AC-150



AC-150

Longer Spout Auto nozzle with high flow, bulk fuel oil delivery service, the biggest advantage is with longer spout, it is used for filling truck, big bus. Flow rate: 150L/min, Spout Length: 350mm, inlet: 1" , outlet: 1"

Inlet Thread	BSPF/NPT 1 "
Diameter of spout	"1"
Color of insulator	red/green/blue/yellow/black
Package	10pcs/carton
Net Weight	14kg
Gross Weight	15kg
Dimension	420×340×400mm

AC-200



AC-200

AC-200A Automatic Nozzles are made of alloy aluminum and designed with big flow rate, and the max flow rate is 260L/min.

Outlet	38mm
Flowrate	260L/min
Inlet	BSPF/NPT 1.5 "
Package	10pcs/carton
Net Weight	24kg
Gross Weight	25kg
Dimension	350×350×520mm

AC-250



AC-250 Manual Nozzles
AC-290 Manual Nozzles

AC-250 and AC-290 nozzle with high flow, bulk fuel oil delivery service, and body with cast aluminum, seals with Buna-N, Viton, main stem: stainless steel

Item	AC-250	AC-290
Spout Outlet	Aluminum 38mm	Aluminum 38mm
Flowrate	260L/min	290L/min
Inlet	BSPF/NPT1.5 "	BSPF/NPT1.5 "
Package	8pcs/carton	8pcs/carton
Net Weight	21kg	20kg
Gross Weight	25kg	24kg
Dimension	350×350×520mm	350×350×520mm

AC-290



Manual Nozzle

AC-2000



Manual Nozzle

For AC-2000, AC-13A, AC-14A Manual Nozzles are made of alloy aluminum and designed with today's customer in mind. Small, trim, light weight, easy and convenient to use.

Inlet Thread	BSPF/NPT 3/4 or 1"
Diameter of spout	1" & 3/4"
Surface treatment	Sand blast or Vibrations
Package	10pcs/carton
Net Weight	13kg
Gross Weight	14kg
Dimension	420×340×400mm
Hose swivel	AC2000,AC13A

AC-12A



AC-13A

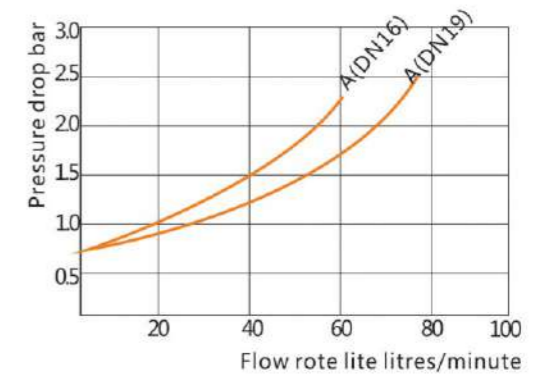

Chemical Nozzle

For AC-5000, AC-6000 Manual plastic Nozzles are made of PP, EDPM and designed with today's customer in mind. Inlet: 3/4" and outlet is 3/4" , and it can fill kind of chemical material, Adblue urea especially use in farm.

AC-5000



AC-6000



LPG Nozzle

LPGNA



LPG Nozzle

LPG nozzle use friendly single-action operation entire fueling operation is initiated by simply engaging nozzle to the receptacle with a single squeeze of the hand. Hammer-Lock technology maximum durability. Designed specifically for frequent coupling and uncoupling. Ergonomic design insulated handle protects operator from temperature effects created by high flowing LP gas. Minimal force required to engage nozzle. Durable construction heavy-duty brass, aluminum and stainless-steel construction provides excellent corrosion resistance in the harsh fueling environment. Ease of use Incorporates with a single plane 360° inlet swivel.

LPGNB



LPGNB Nozzle

Maximum Operating Pressure	350psi
LPG Discharge on Disconnect	4.3cc
Temperature Range	-40°C ~ 85°C (-40°F ~ 185°F)
Coupling Style	Italian Style
Body	Aluminum
Internal Components	Brass/Steel
External Components	Brass/Stainless Steel
Package	10pcs /carton
Net Weight	20 Kg
Gross Weight	21Kg
Dimension	360×320×320 mm

LPG40



LPG40

Model	LPG25	LPG40
Size	25mm/1	40mm/2
Flow Rate	20-120L/mm	40-400L/mm
Accuracy	±0.5	±0.5

LPG Break Away



LPG Break Away

Thread	M27×1.5
Material	Stainless Steel
Max.Pull	120Bar
Flow Rate	5-50L/min

Fuel Filter

GL-7



GL-7-Y

GL-8-Y

GL-3



GL-3

GL-1

GL-4



GL-4-Y

GL-4

GL-5



GL-5-Y

GL-6-Y

Filter and Holder

See-thru Bowl has an easy to use sediment drain valve and allows for visual monitoring of fuel flow. Maximum recommended flow rate of 25 GPM (gravity flow rate is approximately 5 gpm with a 24 inch head); working pressure up to 150 psi. 366 sq. inches of filter surface for efficient action. Standard filter for use with common fuels including regular and unleaded gasoline, diesel fuel, fuel oil, and related additives including methyl, ethyl, and isopropyl alcohol (also compatible with biodiesel blends up to 20 percent). Removes microscopic particles (10 microns) of rust, sand, dirt, scale, and lint. Alum die-cast top cap with 1" NPT pipe fittings. See-Through bowl allows for visual monitoring of fuel flow. Maximum recommended flow rate of 25 GPM; working pressure up to 150 psi.



Item	Holder	Filter	Filter with holder
Material	Aluminum		
Filter thread	UNF1.5"	UNF1.5"	
Inlet	BSPF/NPT1"		BSPF/NPT1"
Outlet	BSPF/NPT1"		BSPF/NPT1"
Package	50pcs/carton	50pcs/carton	25pcs/carton
Net Weight	14Kg	18kg	12Kg
Gross Weight	15Kg	19kg	13Kg
Dimension	330×310×230mm	500×280×350mm	440×500×150mm

Flow Meter

RSJ-50



RSJ50

RSJ-50 is same function with Bennett flow meter, 4 pistons, and machinery sealing, you can use 10,000,000 liter without the mending!

Model	RSJ50	RSJ65/85
Flow Rate	5L-60L/min	5L-65L/min
Disch Rate Per Revo	0.5L	0.5L
Adju Mini Volu	0.05%	0.05%
Accuracy	±0.2%	±0.2%
Repeatable Tole	≤0.05%	≤0.05%
Package	2pcs/carton	2pcs/carton
Net Weight	10kg	11.5kg
Gross Weight	10.5kg	12kg
Dimension	420×260×230mm	420×270×240mm

RSJ.65/85



SS/PP/Alum

ZYB50 ZYB80

ZYB-50/ZYB-80 Vane Pump, built in air separator, by pass valve, filter, is with three different top covers for different connecting pipes. A type. B type and C type. With the advantage of low noise, high flow rate, long life service, etc

Model	ZYB-50	ZYB-80
Speed	630mp	630mp
Flow Rate	45L/min ~ 65L/min	75L/min ~ 85L/min
Vacuum	≥0.054MPa	≥0.054MPa
Noise	≤72dB	≤72dB
Working Pressure	0.16 ~ 0.2MPa	0.2 ~ 0.25MPa
Package	1pcs/carton	1pcs/carton
Dimension	340×260×370mm	340×260×370mm

ZYB-50



Motor 50



380/220V

Submersible turbine pump

STP-240



Submersible turbine pump

- A. Best performance, long time, service, lower noise
- B. Easy to install and service. quick, simple, safe electrical connection.
- C. Manifold allows for vertical or horizontal discharge.
- D. Save, lower service cost.
- E. Built in check valve, by pass valve, vacuum valve.
- F. For diesel, gasoline, kerosene. etc.
- G. vapor-free, suction head longer than suction pump.

Rating pressure	0.1MPa
Max flow rate	200L/M, 240L/M
rotate speed	2820rpm
voltage	220v 50hz
currency	9A
power	1.1KW/1.5H, 1.3KW/1.8H
Ex-proof class	IPx6
Fixation thread	BSPF, NPT 4"
inlet	BSPF, NPT 1.5"
outlet	NPT 2
Adjustable pressure	21kpa-207kpa
Factory pressure range	79kpa-93kpa
working pressure	34kpa

Emergency shut off valve

Working Pressure	0.2MPa
Valve Closing Speed	0.5S
Working Temperature	-30°C ~ 55°C
Flow Range	0 ~ 120L/min
Poppet Valve	Single or double
Inlet	BSPF 1.5"
Outlet	BSPF 1.5"
Thread	Male/Female
Package	10pcs/carton

Ex-proof Motor

- 1.This Motor has been approved by China National Explosion Proof Electronic appliance TEST Center
- 2.It is suitable for use in places where three phase electricity power source is not available
- 3.Technical Data:
Power:750W
Electricity Currency: 5.1A
4.Speed:1400/W



AC-11



AC-09

Nozzle Holder



Nozzle Holder

This type nozzle holder with hall switch, and Ex-proof and CE switch, and its tech details as follows:

Material	Cast Aluminum	Polytene
Package	10pcs/carton	10pcs/carton
Net Weight	7Kg	3Kg
Gross Weight	8Kg	4Kg
Dimension	450×420×400mm	450×420×400mm

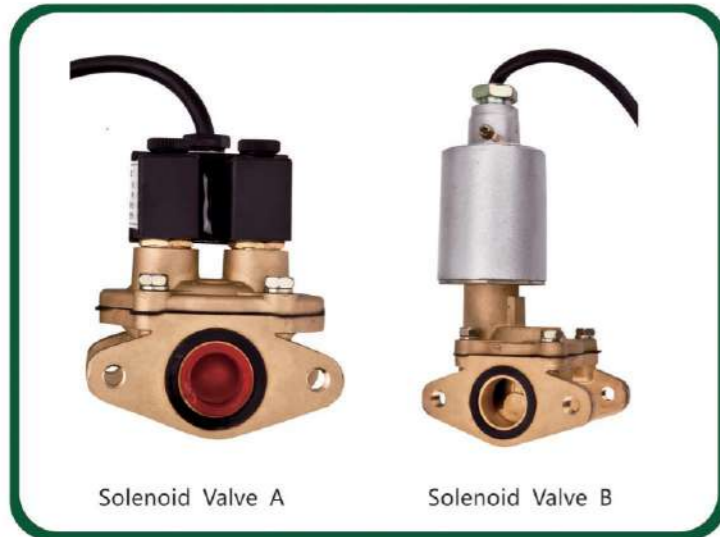

Solenoid Valve A/B

- (1). compact structure, beautiful appearance, leakage quantity is zero.
- (2). it's use in computerized dispenser.

Item	A	B
Package	15pcs/carton	15pcs/carton
Net Weight	13.5Kg	12Kg
Gross Weight	16Kg	14Kg
Dimension	430×360×270mm	430×360×270mm



Pulse

Pulse is 60 and 100 Pulses Available, Output signal as required.

Package	30pcs/carton
Net Weight	12Kg
Gross Weight	13Kg
Dimension	420×340×400mm
Voltage (V+)	+5-36VDC

Breakaway



AC-3/AC-7

AC-3/AC-7 Breakaways built with check valve are used for Connecting the hose and the dispenser. When the pull is too strong, the breakaway will be broken and closed automatically to avoid the fuel flowing.

Model	AC-3	AC-7
Thread	BSPF/NPT	BSPF/NPT
Diameter	"3/4 & 1"	3/4 "
Max.Pull	3/4":250LBS±0.5% 1":300LBS±0.5%	3/4" : 250LBS±0.5%
Flow Range	3/4 " :0 ~ 60L/min 1" :0 ~ 90L/min	3/4" : 0 ~ 60L/min
Package	100pcs/carton	100pcs/carton
Net Weight	3/4 " :28kg 1" :32kg	3/4" : 30kg
Gross Weight	3/4 " :29kg 1" :33kg	3/4" : 31kg
Dimension	520×280×280mm	520×280×280mm



AC-45A,B,C

AC-45A,B,C, Swivels Used for connecting the nozzle and the hose, 360° swivel action.

Item	AC-45A	AC-45B	AC-45C
Thread	BSPF/NPT	BSPF/NPT	BSPF/NPT
Diameter	3/4" & 1"	3/4" & 1"	3/4" & 1"
Package	50pcs/carton	50pcs/carton	50pcs/carton
Net Weight	23kg	18kg	18kg
Gross Weight	24kg	19kg	19kg

Swivels

AC-NS



AC-NSA

AC-NSB

AC-NS

NS-1 Swivels used for AC-11A Automatic Nozzle and AC-120 Automatic Nozzle.

Item	Inlet(Female)	Outlet Male
01	3/4"	3/4"
02	1"	3/4"
03	1"	1"
04	1.5"	1.5"

AC-SYQ Swivels

Item	SYQ4	
Intel Thread	BSPF/NPT	
Diameter	3/4" & 1"	
Package	200pcs/carton	
Net Weight	3/4" : 24kg	1" : 29kg
Gross Weight	3/4" : 26kg	1" : 31kg
Dimension	3/4" : 480×250×350mm	
	1" : 470×250×410mm	

Oil Viewer



AC-SYQ-1

AC-SYQ-2

Foot Valve



AC-13

Valve Closing Speed:
0.5S
Working Temperature:
-30°C ~ 55°C
Thread:
BSPF/NPT 1.5"



AC-SYQ-3



AC-SYQ-4

Rotary Swivels

AC-HS-1A



AC-HS-1AS

AC-HS-1A

AC-HS-1B



AC-HS-1BS

AC-HS-1B

VP Coupler



Filter Angle



HS-1A, HS-1B

HS-1A Rotary Swivels, Used for connecting the nozzle and the hose, 360° swivel action, HS-1B, Un-rotary Swivels Used for connecting the nozzle and the hose.

Item	HS-1A	HS-1B
Thread	BSPF/NPT	BSPF/NPT
Diameter	3/4" & 1"	3/4" & 1"
Package	50pcs/carton	50pcs/carton
Net Weight	23kg	18kg
Gross Weight	24kg	19kg

Brass Filtering

Function: The fuel hose swivel will keep the fuel flow in good condition and the hose will not blind and twist.
Material: The fuel swivel is made of brass alloy with powder on surface. It is rust and corrosion resistant.
Size: The fuel swivel has male and female 3/4 inch. Easy installation: The fuel swivel IS NPT and can be installed easily. Warranty: 1-YEAR / 365-DAYS UNLIMITED MILEAGE WARRANTY.



Filter



AC-15

AC-16



FLOW METER SERIES

website: www.china-aocheng.com



Positive Displacement Flow Meter

M-50-1



M Series

It is with excellent stepless adjusting mechanism allows a micro adjustment of the meter .
 High accuracy and repeatability over the widest range of flow; Superior accuracy at constant flow.
 Low maintenance, no metal-to-metal contact in measuring chamber, long life service.
 Low pressure loss, a true gravity flow meter.
 Accuracy regardless of pressure fluctuations, temperature variation, viscosity.
 Choice of aluminum, cast iron and stainless steel materials of construction.

Model	M-40-1	M-50-1 M-50H-1	M-80-1 M-80H-1	M-100-1 M-150-1
Size	40mm/1.5"	50mm/2"	80mm/3"	100mm/4" 150mm/6"
Flow Range (L/min)	25-250	38-380 55-550	75-750 15-1150	170-1700 300-3000
Volume Per Rev	0.309L	0.681L	1.839L	5.102L 9.507L
Max Pressure	10Bar/150PSI			
Accuracy	±0.2%			
Repeatability	≤0.05%			
Standard Measurement	Liter / US Gallon /IMP Gallon			

Model	YB-50	YB-65	YB-80
Size	50mm/2"	65mm/2.5"	80mm/3"
Flow Range (L/min)	150-300	300-500	600-1000
Pump Speed(rpm)	400-640	400-640	400-640
Vacuum	0.5Bar		
Max Pressure	5Bar/75PSI		
Motor	2.2/4/7.5Kw		
Noise	70db		

Machinery Register



YB-50



Positive Displacement Vane Meter

SM-50-1



SM Series

Model	SM-50	SM-80
Size	50mm / 2"	80mm / 3"
Volume Per Revolution	0.4L/0.1US Gallons	2.27L/0.6US Gallons
Max. Flow Rate	400L/min	1333L/min
Min. Flow Rate	40L/min	133.3L/min
Accuracy	±0.2%	
Repeatability	≤0.05%	
Working Temperature Range	-40°C ~ +60°C	
Max. Viscosity	800cps/3850 SSU	

FM-50



FMC Series PD Rotary Vane Flow Meter

Model	FMC-50	FMC-80	FMC-100
Size	50mm / 2"	80mm / 3"	100mm / 4"
Flow Rate(L/min)	38-380	75-750	150-1500
Working Pressure	150PSI		
Accuracy	±0.2%		
Repeatability	0.07%		

OGM-I



OGM-I-40/50/80 Cast Iron Oval Gear Meter

Model	OGM-I-50	OGM-I-80	OGM-I-50
Size	2"	3"	4"
Min.Flow Rate	60L/min	140L/min	160L/min
Max.Flow Rate	300L/min	700L/min	1600L/min
Accuracy	±0.2%or±0.5%	±0.2%or±0.5%	±0.2%or±0.5%
Repeatability	≤0.03%	≤0.03%	≤0.03%
Max.Operating Pressuer	1.8MPa	1.8MPa	1.8MPa

Oval Gear Meter

OGM25-0.5



OGM-25/40/50 Oval Gear Meter

OGM-25/40/50 aluminum oval gear meter has the ability to handle a wide range of fluid viscosities with exceptional levels of repeatability and durability, applying in the petroleum, chemical, food industry etc. and it has big advantages as follows:

- A. Low pressure drop
- B. Compact size, easy maintenance
- C. Easy to read and operate mechanical display
- D. Horizontally and vertically flexibility of installation options
- E. 5-digit sub-total, with floating point from 0.01 to 99999.99, 7-digit non-resettable totalizer.
- F. 3.6V lithium battery power, durable service

OGM-12



OGM-25



OGM-25

OGM-40-D

Model	OGM-25	OGM-40	OGM-50
Size	1"	1.5"	2"
Min.Flow Rate	20L/min	25L/min	30L/min
Max.Flow Rate	120L/min	250L/min	300L/min
Accuracy	±0.5%	±0.5%	±0.5%
Repeatability	≤0.03%	≤0.03%	≤0.03%
Max.Viscosity	1000CPS	1000CPS	1000CPS
Max.Operating Pressuer	3.4MPa	1.8MPa	1.8MPa



OGM-25-P



OGM25-PRET



Measuring Nozzle

AC-18



AC-18/28/38

AC-18

1. This measuring nozzle develops on the basis of nozzle AC-11A which is more stable and auto-shut off
2. Its accuracy is 30% higher than other measuring nozzles.
3. It has 3 different flow rate, 12-60 L/min, 20-120 L/min, 8-45 L/min.
4. It can be used for urea, gasoline, diesel and methanol, etc.
5. The screen can display unit price, liter, sale, total liter, total amount and flow rate per minute.

Model	AC-18	AC-28	AC-38
Inlet & Outlet	BSPF3/4"	BSPF1"	BSPF3/4"
Material	aluminum	aluminum	teflon
Accuracy	±0.5%	±0.5%	±0.5%
Medium	Gasoline Diesel	Diesel	AdBlue, Methanol
Per revolution	25ml/r	25ml/r	25ml/r
Battery power	2x1.5v	2x1.5v	2x1.5v
Flow rate	12-60L/min	20-120L/min	8-45L/min

AC-LLY



LLY-25

LLY-25D

LLY Nozzle

1. LLY serious screw wing type measuring nozzle is the meter to measure volume flow of liquid flowing through pipes. Measurement accuracy: ±1%
2. Measured media: Gasoline, If the medium is kerosene, diesel, we should correct it according to the measuring tank, for more correcting details, please check according to item V below.
3. The maximum working pressure: 0.1Mpa

Model	Nominal Diameter (mm)	Minimum Flow (L/min)	Nominal Flow (L/min)	Maximum Flow (L/min)	Meter Value
LLY-15	15	15	25	40	1 ~ 9999
LLY-25	25	25	35	60	1 ~ 9999
LLY-32	32	32	60	100	1 ~ 9999
LLY-38	38	38	80	120	1 ~ 9999



AC-16A



Turbine Measuring Nozzle

AC-15A



AC-15A

15A serious screw turbine type measuring nozzle is the meter to measure volume flow of liquid flowing through turbine. For gasoline, kerosene, fueling diesel etc. Measuring nozzle is with high precision, and flexible etc. the best advantage is that we can re-correct the error according to different medium. Measured media: Gasoline, If the medium is kerosene, diesel, we should correct it according to the measuring tank, for more correcting details, please check according to the product instruction

1. Nominal diameter and flow:

Model	Accuracy	Working Pressure	Inlet out let	Maximum Flow (L/min)	Meter Value
15A	±0.5%	0.1Mpa	1"	120	1 ~ 9999

2. Color: Red, Black, Yellow, Blue

AC-TM1.0



AC-TM1.0/1.5/2.0

Turbine Measuring Meter

Model	AC-TM1	AC-TM1.5	AC-TM2.0
Inlet & Outlet	NPT1"	NPT1.5"	NPT2"
Accuracy	±1%	±1%	±0.5%
Material	alum 304	alum 304	alum 304
Max working pressure	0.7mpa	0.7mpa	0.7mpa
Battery power	2x1.5v	2x1.5v	2x1.5v
Flow rate	10-100L/min	20-200L/min	30-300L/min

AC-TM1



Machinery Meter

FM-120-1



FM-120-2



FM-120-3



FM-120-4



FM-120

Machinery Flow Meters, designed for metering diesel fuel, gasoline, kerosene, mineral spirits, with the advantage of Large, easy to read numbers, Quick reset knob, Flexible flow ports can be positioned vertically or horizontally. The easy reset register indicates product use up to 999.9 gallons or liters. The master tanzaler registers up to 99999999 gallons or liters.

Item	FM-120-1	FM-120-2	FM-120-3	FM-120-4
Measurement	Litre/US Gallon	Litre/US Gallon	Litre/US Gallon	Litre/US Gallon
Max. Pressure	3 Bar.	3 Bar.	3 Bar.	3 Bar.
Flow Rate	150LPM	120LPM	120LPM	100LPM
Inlet Outlet:	BSPF/NPT 1" or 1.5"	BSPF1"	BSPF1"	BSPF1"
Precision	±1%	±1%	±1%	±1%
Package	6pcs/carto	6pcs/carton	6pcs/carton	6pcs/carton
Net Weight	15Kg	12Kg	12Kg	9Kg
Gross Weight	16Kg	13Kg	13Kg	10Kg
Dimension	520×260×350mm	520×260×350mm	520×260×350mm	520×260×350mm

12V Register



Register

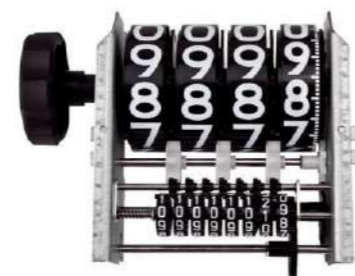

Manual Pump

TS Type



TS-50



TS-51-PP

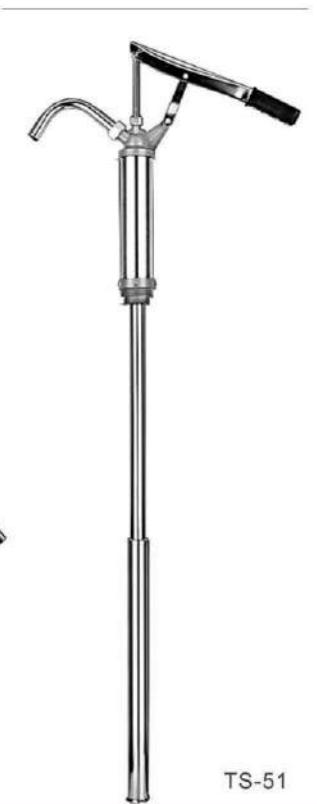

TS-51

TS Type



TS-32-ALUM

TS Type



TS-32-NL

TS-32-PP

TS-32

Quick Coupling



Quick Coupling Size

A	B	C	D	E	F	DP	DC
1/2"	1/2"	1/2"	1/2"	1/2"	1/2"	1/2"	1/2"
3/4"	3/4"	3/4"	3/4"	3/4"	3/4"	3/4"	3/4"
1"	1"	1"	1"	1"	1"	1"	1"
1.2"	1.2"	1.2"	1.2"	1.2"	1.2"	1.2"	1.2"
1.5"	1.5"	1.5"	1.5"	1.5"	1.5"	1.5"	1.5"
2"	2"	2"	2"	2"	2"	2"	2"
2.5"	2.5"	2.5"	2.5"	2.5"	2.5"	2.5"	2.5"
3"	3"	3"	3"	3"	3"	3"	3"
4"	4"	4"	4"	4"	4"	4"	4"
5"	5"	5"	5"	5"	5"	5"	5"
6"	6"	6"	6"	6"	6"	6"	6"

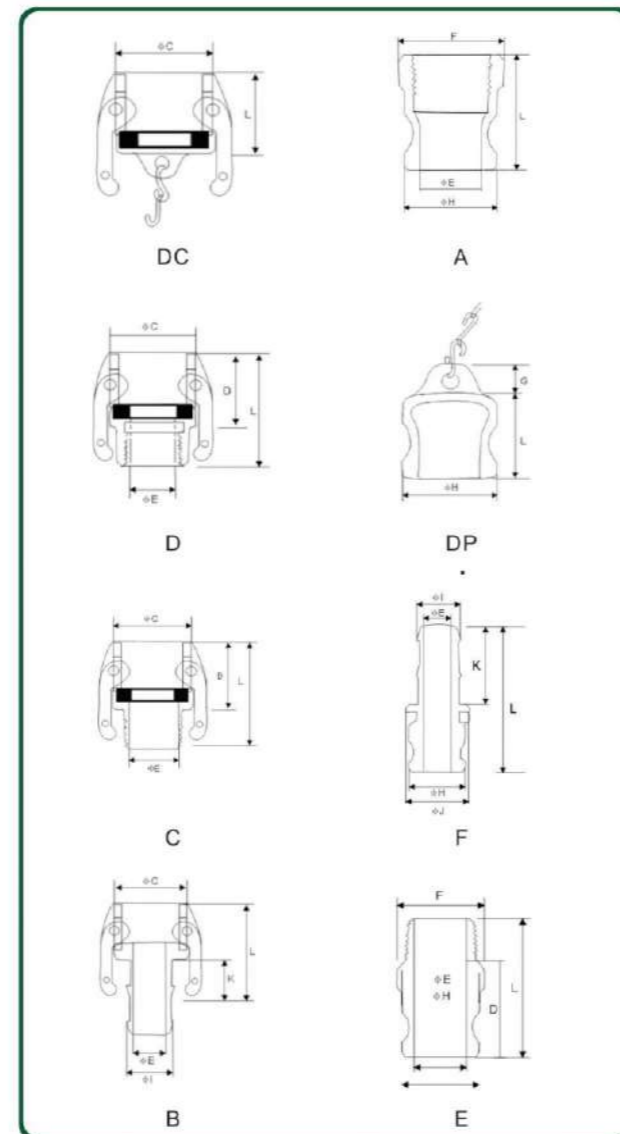

Oil Tank Accessories



Oil Tank Accessories



Measuring Tool/Oil Pump





DARF
PROJECT ADVISORS



卷盘工业专家
Hose Reel Technology Solutions

30 YEARS EXPERIENCE
30年的生产经验



SINCE 1985



DARF
PROJECT ADVISORS



AOCHENG COMPANY Introduction 奥诚公司简介



Yongjia Aocheng Hardware Co., Ltd. established in 2007 has been manufacturing diesel hose reel, grease hose reel, oil hose reel, air/water hose reel, adblue hose reel and its accessories for more than 30 years.

After spending a lot of years in developing markets, Aocheng Hardware has established more than two factories which are expert in manufacturing hose reel related accessories.

Our management system passed ISO9000:2000 certificated in the year 2009 and CE certificated in the year 2008. We also have many products that are under the process of UL approval.

At present, our company exports 70% of our products which are produced by our professional staff members. We hope to share with you our ingeniousness and collaborative spirit that enable our company to succeed.

永嘉县奥诚五金制品有限公司(创立于2007年)主要生产, 研发和销售: 柴油卷盘, 黄油卷盘, 机油卷盘, 水、空气卷盘, 尿素卷盘等产品。

经过几年发展和耕耘,奥诚现在拥有两个卷盘及附件制造厂,分别位于温州市龙湾区和永嘉县。管理体系通过了ISO9000:2000认证, 产品通过了CE和RoHS认证, 部分产品通过了UL认证。

现在我们已有70%的产品出口到国外, 更重要的是, 我们有专业的团队, 不屈和共赢的精神, 努力为客户提供最高性价比的产品。



AOCHENG Contents

卷盘产品目录

带泵自动卷管器 DISPENSER HOSE REEL	>>01-02
柴油自动卷管器 DIESEL HOSE REEL	>>03-04
黄油高压卷管器 GREASE HOSE REEL	>>05-06
机油自动卷管器 OIL HOSE REEL	>>07-08
空气/水自动卷管器 AIR/WATER HOSE REEL	>>09-10
尿素卷管器 ADBLUE HOSE REEL	>>11-12





Dispenser Hose Reel

带泵自动卷管器



Dispenser unit with automatic hose reel, the 15 metres of hose with automatic nozzle allows dispensing up to 45L/min with DC power supply. The automatic hose reel, the DC pumps and the automatic nozzle are integrated in a sturdy supporting structure. Easy to install, versatile, compact, necessary to complete mobile or fixed tanks.

集高效率, 高性能, 高强度为一体的带泵自动卷管器开创了我国卷管器市场新的篇章, 设计美观, 操作简便, 自带油泵 (45L/min), 滤网和加油枪, 广泛用于移动油罐车, 工程队, 内部车队加油等领域。

Main Technical Data/ 主要技术数据

型号 Code	描述 Description	介质 Fluids	工作压力 Working Pressure	管子长度 Hose Length	进口 Inlet	出口 Outlet
HRF3415-12V	Hose reel with 15m hose, 12V, 45L/min, 200W	Diesel, Kerosen, 柴油, 煤油	20bar	15m	BSP1" M	BSP3/4" M
HRF3415-24V	Hose reel with 15m hose, 24V, 45L/min, 300W	Diesel, Kerosen, 柴油, 煤油	20bar	15m	BSP1" M	BSP3/4" M



Product introduction/ 产品介绍



Rohs
compliant

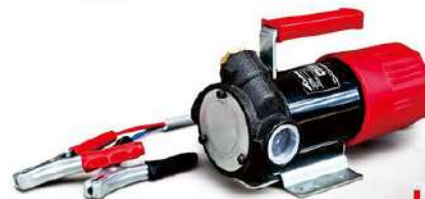

HRF3415
Dispenser Hose Reel



Dispenser Hose Reel 带泵自动卷管器

Accessories/ 配件



Consists of/ 由下列配件组成:



1. Automatic hose reel/ 自动回收卷盘
2. Adjustable arms with end-of-travel hose stop/ 可以自由调整的支撑臂和夹管器
3. Diesel hose 3/4"-14m (1"-10m)/ 1.4米3/4"的油管, (10米1"的油管)
4. On/Off switch/ 开关
5. Swivel/ 旋转接头
6. Automatic nozzle/ 自封枪
7. DC pump/ 直流泵
8. Sturdy metal structure/ 自带油水分离的过滤网
9. Filter of the water absorption cartridge type/ 带油水分离的过滤网
10. One request: Fitting of K24, digital turbine meter/ 可以选配K24的电子枪。
11. Available in 80L/min version with 10metres of hose/ 80L/min的泵带10米油管。

Dimension/ 尺寸

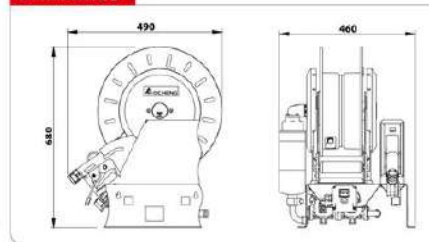



Product Introduction/产品介绍



HRD3410
Diesel Hose Reel

Rohs
compliant



Diesel Hose Reel

柴油自动卷管器

Automatic hose reels for diesel and oil have been designed to ensure high efficiency. The sturdy structure can guarantee best performance also in heavy duty conditions.

集高效率,高性能,高强度为一体的柴油自动卷管器开创了我国柴油卷管器市场新的篇章,设计美观,振奋精神,操作简便,广泛用于油罐车,工程保养车,内部车队加油车间等领域。

Features/特点

- ◆ The 4 reel ball bearings on the arms facilitate the unrolling of the hose, avoiding friction that would cause a gradual deterioration
- ◆ The hose can be locked at the desired length
- ◆ Ratchet prevents unlock when hose is completely extended
- ◆ Corrosion resistant: the hot galvanized
- ◆ steel structure is moulded and coated with electrostatic polyester powder UV rays resistant
- ◆ Easy and versatile installation through the rotating support plate and the adjustable arm positions
- ◆ spring-driven retractable hose
- ◆ Hose stop, reduce pressure loss
- ◆ Compatibility: all bolts and nuts use stainless steel

- ◆ 出口4个滚轮构造有利于软管的伸缩自如,避免软管和其它物摩擦导致其磨损。
- ◆ 油管拉出来有不同的长度固定档位。
- ◆ 如果管子全部拉出来了,定位棘轮就处于不定位状态,以防止死机
- ◆ 高耐腐蚀:全部用热镀锌钢板成型,表层涂采用静电喷涂且耐紫外线。
- ◆ 采用左右推动底座板和引导臂不同位置的变动,很容易安装且方便灵活。
- ◆ 带逆置回收装置。
- ◆ 带管夹,以防止油管被全部拉进去。

Dimension/尺寸

Model 型号	A	B	C	D	E	F	G	H
HOSE REEL XL	500	475	155	240	202	220	163	10.5

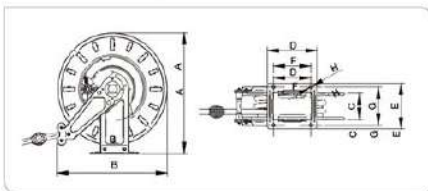

Diesel Hose Reel 柴油自动卷管器

Specifications/技术参数如下

- ◆ Spring driven double arm hose reel
- ◆ Designed to transfer diesel, petrol, kerosene
- ◆ Heavy duty construction for long life in industrial and automotive applications
- ◆ High quality impact resistant steel drum
- ◆ maximum working pressure 20bar
- ◆ All fittings (fluid pass) in CuZn40Pb2 (brass).
- ◆ Wall, ceiling or floor mounted
- ◆ BSP3/4" or 1" BSP Inlet/outlet

- ◆ 输送柴油,煤油,汽油领域
- ◆ 高强度,高寿命设计,广泛运用于加油工业和汽车保养等领域
- ◆ 高品质,耐冲击卷盘
- ◆ 最大工作压力,一般在20bar.
- ◆ 过介质零件都采用黄铜(CuZn40Pb2)材质
- ◆ 可安装在墙壁,地板或天花板上
- ◆ 进出口 BSP3/4" or 1"
- ◆ 弹簧驱动的双臂软管卷盘
- ◆ 所有的螺栓螺母都是用不锈钢304



Technical Data/技术参数表

型号 Code	描述 Description	介质 Fluids	工作压力 Working Pressure	管子长度 Hose Length	进口 Inlet	出口 Outlet
HRD3410	Hose reel without 10m hose (不带管)	Diesel,Kerosen, 柴油,煤油	20bar	/	BSP3/4" M	BSP3/4" M
HRD3410D	Hose reel with 10m diesel hose (带柴油管)	Diesel,Kerosen, 柴油,煤油	20bar	10m	BSP3/4" M	BSP3/4" M
HRD3410J	Hose reel with 10m petrol hose (带汽油管)	Diesel,Kerosen, 柴油,煤油	20bar	10m	BSP3/4" M	BSP3/4" M
HRD3410	Hose reel without 10m hose (不带管)	Diesel,Kerosen, 柴油,煤油	20bar	/	BSP3/4" M	BSP3/4" M
HRD3415	Hose reel without 15m hose (不带管)	Diesel,Kerosen, 柴油,煤油	20bar	/	BSP3/4" M	BSP3/4" M
HRD3415J	Hose reel with 15m petrol hose (带汽油管)	Diesel,Kerosen, 柴油,煤油	20bar	15m	BSP3/4" M	BSP3/4" M
HRD1110	Hose reel without 10m hose (不带管)	Diesel,Kerosen, 柴油,煤油	20bar	/	BSP1" M	BSP1" M
HRD1110D	Hose reel with 10m diesel hose (带柴油管)	Diesel,Kerosen, 柴油,煤油	20bar	10m	BSP1" M	BSP1" M
HRD1110J	Hose reel with 10m petrol hose (带汽油管)	Diesel,Kerosen, 柴油,煤油	20bar	10m	BSP1" M	BSP1" M
HRD1115	Hose reel without 15m hose (不带管)	Diesel,Kerosen, 柴油,煤油	20bar	/	BSP1" M	BSP1" M
HRD1115D	Hose reel with 15m diesel hose (带柴油管)	Diesel,Kerosen, 柴油,煤油	20bar	15m	BSP1" M	BSP1" M
HRD1115J	Hose reel with 15m petrol hose (带汽油管)	Diesel,Kerosen, 柴油,煤油	20bar	15m	BSP1" M	BSP1" M
HRP3410	Hose reel without 10m hose (不带管)	Petrol 汽油	20bar	/	BSP3/4" M	BSP3/4" M
HRP3410J	Hose reel with 10m diesel hose (带柴油管)	Petrol 汽油	20bar	10m	BSP3/4" M	BSP3/4" M



Grease Hose Reel

黄油高压卷管器



The automatic hose reels are projected to work up to 400 BAR pressure. It can be used in all industries, workshops, service stations, garages, etc. They are built with high standard quality and attention to material to provide high performances.

自动黄油高压卷管器是广泛应用于工作压力高出400bar的输送领域, 比如重型工业、制造车间、4S店车间、车库、洗车店等场所。提供高标准, 高性能的产品是我们永恒的追求

Features/ 特点

- ◆ The 4 reel ball bearings on the arms facilitate the unrolling of the hose, avoiding friction that would cause a gradual deterioration
- ◆ The hose can be locked at the desired length
- ◆ Ratchet prevents unlock when hose is completely extended
- ◆ Corrosion resistant: the hot galvanized
- ◆ steel structure is moulded and coated with electrostatic polyester powder UV rays resistant
- ◆ Easy and versatile installation through the rotating support plate and the adjustable arm positions
- ◆ spring-driven retractable hose
- ◆ Hose stop, reduce pressure loss
- ◆ Compatibility: all bolts and nuts use stainless steel
- ◆ 出口4个滚轮构造有利于软管的伸缩自如, 避免软管和其它部件摩擦导致其磨损。
- ◆ 软管拉出来有不同的长度固定档位。
- ◆ 如果管子全部拉出来了, 定位棘轮就处于不定位状态, 以防止死机。
- ◆ 高耐腐蚀: 全部用热镀锌钢板成型, 表层涂采用静电喷塑且耐紫外线。
- ◆ 采用左右摆动底座板和引软管不同位置的变动, 很容易安装且方便灵活。
- ◆ 带弹簧回收装置。
- ◆ 带管夹, 以防止油管被全部拉进去。

Accessories/ 配件



HRG1415

Dispenser Hose Reel



Specifications/ 技术参数如下

- ◆ Spring driven double arm hose reel
- ◆ Designed to transfer grease, higher pressure water
- ◆ Heavy duty construction for long life in industrial and automotive applications
- ◆ High quality impact resistant steel drum
- ◆ Maximum working pressure 400bar
- ◆ All fittings (fluid pass) in CuZn40Pb2 (brass).
- ◆ Wall, ceiling or floor mounted
- ◆ 1/4", 3/8" NPT Inlet/outlet.
- ◆ 输送黄油高压水枪等场合。
- ◆ 高强度高寿命设计广泛运用于工程机械工业和汽车保养等领域。
- ◆ 高品质的卷盘设计。
- ◆ 最大工作压力: 400bar
- ◆ 过介质零件都采用黄铜(CuZn40Pb2)材质
- ◆ 可安装在墙壁, 地板或天花板上
- ◆ 进出口NPT: 1/4", 3/8"
- ◆ 弹簧驱动的双臂软管卷盘
- ◆ 所有的螺栓螺母都是用不锈钢304

Dimension/ 尺寸

Model/型号	A	B	C	D	E	F	G	H
HOSE REEL SMALL	490	446	130	240	140	200	105	10.5

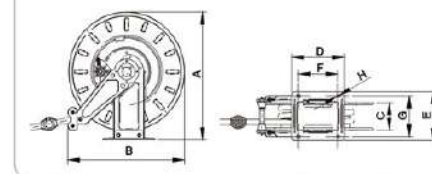

Technical Data/ 技术参数表

型号 Code	描述 Description	介质 Fluids	工作压力 Working Pressure	管子长度 Hose Length	进口 Inlet	出口 Outlet
HRG1415	Hosereel without 15m hose (不带管)	Grease Water, 黄油, 水	400bar	/	NPT1/4" M	NPT1/4" M
HRG1415A	Hose reel with 15m hose (带管)	Grease Water, 黄油, 水	400bar	15m	NPT1/4" M	NPT1/4" M
HRA3815	Hosereel without 15m hose (不带管)	Grease Water, 黄油, 水	400bar	/	NPT3/8" M	NPT3/8" M
HRA3815A	Hose reel with 15m hose (带管)	Grease Water, 黄油, 水	400bar	15m	NPT3/8" M	NPT3/8" M



Product Introduction/ 产品介绍



RoHS
compliant

Dimension/ 尺寸

Model/型号	A	B	C	D	E	F	G	H
HOSE REEL SMALL	480	445	130	240	140	200	105	10.5



Accessories/ 配件



Oil Hose Reel

机油自动卷管器



The automatic oil hose reels are projected to work up to 150 BAR pressure. It can be used in all industries, workshops, service stations, garages, etc. They are built with high standard quality and attention to material to provide high performances.

自动机油高压卷管器是广泛应用于工作压力高出150bar的输送领域,比如重型工业、制造车间、4S店车间、车库、洗车店等场所。



Hose reel installations:

1. Roof installation
2. Wall installation
3. Ground installation

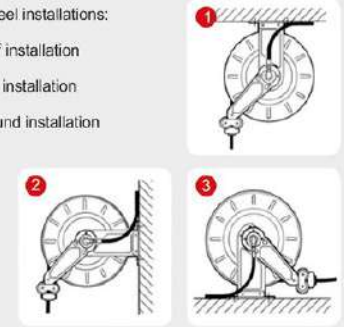

Oil Hose Reel 油嘴卷管器

Features/ 特点

- The 4 reel ball bearings on the arms facilitate the unrolling of the hose, avoiding friction that would cause a gradual deterioration
 - The hose can be locked at the desired length
 - Ratchet prevents unlock when hose is completely extended
 - Corrosion resistant: the hot galvanized
 - steel structure is moulded and coated with electrostatic polyester powder UV rays resistant
 - Easy and versatile installation through the rotating support plate and the adjustable arm positions
 - spring-driven retractable hose
 - Hose stop, reduce pressure loss
 - Compatibility: all bolts and nuts use stainless steel
- 出口4个滚轮构造有利于软管的伸缩自如,避免软管和其它物摩擦导致其破损。
 - 油管拉出未有不同的长度固定档位。
 - 如果管子全部拉出来了,定位棘轮就处于不定位状态,以防止死机
 - 高耐腐蚀:全部用热镀锌钢板成型,表层涂采用静电喷塑且耐紫外线。
 - 采用左右震动底座板和引导臂不同位置的变动,很容易安装且方便灵活。
 - 带弹簧回收装置。
 - 带管夹,以防止油管被全部拉进去。

Specifications/ 技术参数如下

- Spring driven double arm hose reel
 - Designed to transfer Oil
 - Heavy duty construction for long life in industrial and automotive applications
 - High quality impact resistant steel drum
 - maximum working pressure 150bar
 - All fittings (fluid pass) in CuZn40Pb2 (brass).
 - Wall, ceiling or floor mounted
 - NPT1/2", 3/8" Inlet/outlet
- 输送机油等场合。
 - 高强度高寿命设计广泛运用于工程机械工业和汽车保养等领域。
 - 高品质的卷盘设计
 - 最大工作压力:150bar
 - 过介质零件都采用黄铜(CuZn40Pb2)材质
 - 可安装在墙壁,地板或天花板上
 - 进出口: NPT1/2"
 - 弹簧驱动的双臂软管卷盘



Technical Data/ 技术参数表

型号 Code	描述 Description	介质 Fluids	工作压力 Working Pressure	管子长度 Hose Length	进口 Inlet	出口 Outlet
HRO1215	Hosereel without 15m hose (不带管)	Oil Lub, 机油, 润滑油	150bar	15m	NPT1/2" M	NPT1/2" M
HRO1215A	Hose reel with 15m hose (带管)	Oil Lub, 机油, 润滑油	150bar	15m	NPT1/2" M	NPT1/2" M
HRO1210A	Hose reel with 15m hose (带管)	Oil Lub, 机油, 润滑油	150bar	10m	NPT1/2" M	NPT1/2" M



Product introduction/产品介绍



Rohs compliant



HRA3815A
Air/Water Hose Reel

Dimension/尺寸

Model	A	B	C	D	E	F	G	H
OPEN REEL SMALL	480	445	130	240	140	200	105	10.5

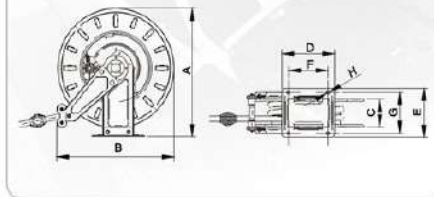

Changpinpeiian/配件



Cleaning tanker



Foam Lance



Spray Gun



Air/water Hose Reel

空气/水自动卷管器

Automatic Air/water hose reels have been designed to ensure high efficiency. The sturdy structure can guarantee best performance also in heavy duty conditions.

集高效率、高性能、高强度为一体的水、气自动卷管器开创了水、气卷管器市场新的篇章，设计美观，振奋精神，操作简便，广泛用于油罐车，工程保养车，内部车队等领域。



Hose reel installations:

1. Roof installation
2. Wall installation
3. Ground installation

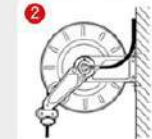

Features/特点

- The 4 reel ball bearings on the arms facilitate the unrolling of the hose, avoiding friction that would cause a gradual deterioration
- The hose can be locked at the desired length
- Ratchet prevents unlock when hose is completely extended
- Corrosion resistant: the hot galvanized
- steel structure is moulded and coated with electrostatic polyester powder UV rays resistant
- Easy and versatile installation through the rotating support plate and the adjustable arm positions
- spring-driven retractable hose
- Hose stop, reduce pressure loss
- Compatibility: all bolts and nuts use stainless steel

- 出口4个滚轮构造有利于软管的伸缩自如，避免软管和其它物摩擦导致其磨损。
- 管拉出来有不同的长度固定档位。
- 如果管子全部拉出来了，定位棘轮就处于不定位状态，以防止死机
- 高耐腐蚀：全部用热镀锌钢板成型，表层涂采用静电喷粉且耐紫外线。
- 采用左右摆动底座板和引导臂不同位置的变动，很容易安装且方便灵活。
- 带弹簧回收装置。
- 带管夹，以防止管被全部拉进去。

Specifications/技术参数如下

- Spring driven double arm hose reel
- Designed to transfer Air, higher pressure water
- Heavy duty construction for long life in industrial and automotive applications
- High quality/impact resistant steel drum
- maximum working pressure 400bar
- All fittings (fluid pass) in CuZn40Pb2 (brass).
- Wall, ceiling or floor mounted
- NPT1/4", 3/8" Inlet/outlet

- 输送高压水、气领域
- 高强度，高寿命设计，广泛运用于汽车保养等领域
- 高品质的卷盘设计
- 最大工作压力，可以选择不同管子，一般管在400bar，
- 过介质零件都采用黄铜(CuZn40Pb2)材质
- 可安装在墙壁，地板或天花板上
- 进出口 NPT3/4" or 3/8"
- 弹簧驱动的双臂软管卷盘
- 所有的螺栓螺母都是用不锈钢304



Technical Data/ 技术参数表

型号 Code	描述 Description	介质 Fluids	工作压力 Working Pressure	管子长度 Hose Length	进口 Inlet	出口 Outlet
HRA3815A	Hose reel with 15m hose (带管)	Air, Water, 空气, 水	20/350bar	15m	NPT3/8" M	NPT3/8" M
HRA1215A	Hose reel with 15m hose (带管)	Air, Water, 空气, 水	20/350bar	15m	NPT1/2" M	NPT1/2" M

Air/Water Hose Reel 空气/水自动卷管器



Product introduction/ 产品介绍



Rohs
compliant



Dimension/ 尺寸

Model	A	B	C	D	E	F	G	H
HOSE REEL	500	475	155	240	202	200	163	10.5

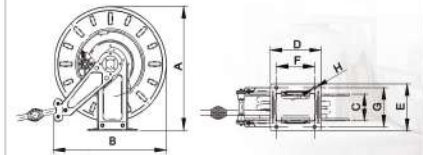

Accessories/ 配件



Adblue pump



Adblue Nozzle(M)



Adblue Meter



Hosereel Kit base (available)

AdBlue Hose Reel

尿素卷管器



Automatic hose reel for AdBlue® filling tanks. All the components are compatible with urea in order to avoid parts corrosion, so to prevent urea contamination.

自动回收尿素卷管器是一种高强度高耐腐蚀科技解决方案, 广泛用于汽车工业尿素加注领域。



AdBlue Hose Reel 副牌型号系列

Features/ 特点

- ◆ The 4 reel ball bearings on the arms facilitate the unrolling of the hose, avoiding friction that would cause a gradual deterioration
- ◆ The hose can be locked at the desired length
- ◆ Ratchet prevents unlock when hose is completely extended
- ◆ Corrosion resistant: the hot galvanized
- ◆ steel structure is moulded and coated with electrostatic polyester powder UV rays resistant
- ◆ Easy and versatile installation through the rotating support plate and the adjustable arm positions
- ◆ spring-driven retractable hose
- ◆ Hose stop, reduce pressure loss
- ◆ Compatibility: all bolts and nuts use stainless steel
- ◆ 出口4个滚轮构造有利于软管的伸缩自如, 避免软管和其它物摩擦导致其破损。
- ◆ 尿素管拉出来有不同的长度固定档位。
- ◆ 如果管子全部拉出来了, 定位棘轮就处于不定位状态, 以防止死机
- ◆ 高耐腐蚀: 全部用热镀锌钢板成型, 表层涂采用静电喷塑且耐紫外线。
- ◆ 采用左右摆动底座板和引导臂不同位置的变动, 很容易安装且方便灵活。
- ◆ 带弹簧回收装置。
- ◆ 带管夹, 以防止尿素管被全部拉进去。

Specifications/ 技术参数如下

- ◆ Spring driven double arm hose reel
- ◆ Designed to transfer Adblue, chemical
- ◆ Heavy duty construction for long life in industrial and automotive applications
- ◆ High quality impact resistant steel drum
- ◆ Maximum pressure 300psi(20bar)
- ◆ All fittings (fluid pass) in 304 stainless steel
- ◆ Wall, ceiling or floor mounted
- ◆ 8 metre EDPM hose and 1 meter EDPM connection hose
- ◆ 3/4" BSP Inlet/outlet
- ◆ 输送尿素, 低腐蚀性化工场合。
- ◆ 高强度, 高寿命设计, 广泛运用于汽车, 化工领域。
- ◆ 高品质的卷盘设计
- ◆ 最大工作压力: 20bar
- ◆ 过介质零件都采用304不锈钢材质
- ◆ 可安装在墙壁, 地板或天花板上
- ◆ 8米EDPM出管和1米EDPM进管
- ◆ 进出口BSP: 3/4"
- ◆ 弹簧驱动的双臂软管



Technical Data/ 技术参数表

型号 Code	描述 Description	介质 Fluids	工作压力 Working Pressure	管子长度 Hose Length	进口 Inlet	出口 Outlet
HRA008	Hosereel without 15m hose (不带管)	Adlue, Urea	20bar	/	3/4"	3/4"
HRA008A	Hose reel with 15m hose (带管)	Adlue, Urea	20bar	8m	3/4"	BSP3/4" M
HRA015	Hosereel without 15m hose (不带管)	Adlue, Urea	20bar	/	3/4"	3/4"
HRA015A	Hose reel with 15m hose (带管)	Adlue, Urea	20bar	15m	3/4"	BSP3/4" M